

Focus Ds

600x600, 1200x600, 1600x600, 1800x600,
2000x600, 2400x600,
625x625, 1250x625z,
24"x24", 2'x5', 2'x6', 2'x8'

M206

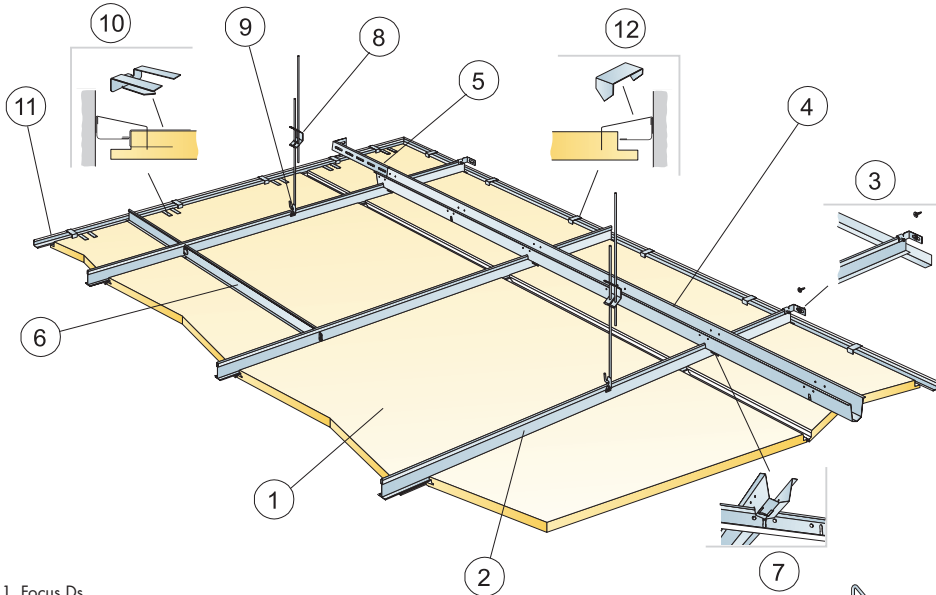
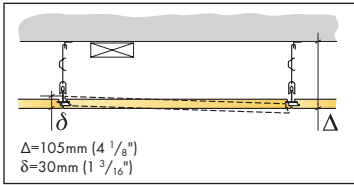

- 1. Focus Ds
- 2. Connect T-24 Main runner HD

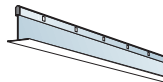

- 3. Connect Wall bracket

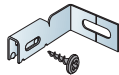

- 4. Connect Space bar

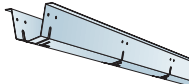

- 5. Connect Wall bracket

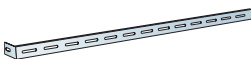

- 6. Connect T-24 Cross tee,
L=600/625/24"

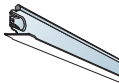

- 7. Connect Space bar winch



- 8. Connect Adjustable hanger



- 9. Connect Hanger clip



- 10. Connect Support clip Dg20

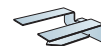

- 11. Connect Angle trim 15/22, fixed at 300
mm centres

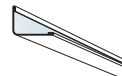

- 12. Connect Perimeter tile clip



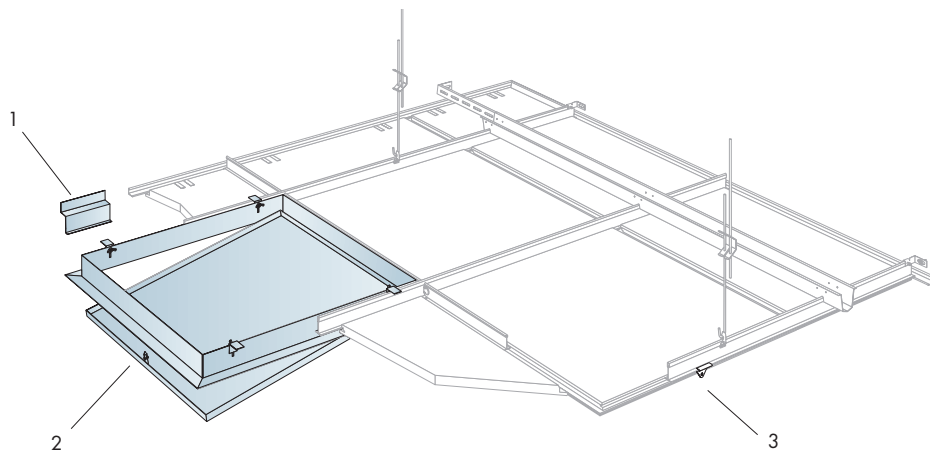

1. Connect Distance trim

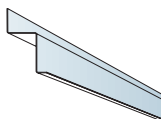

2. Connect Inspection panel

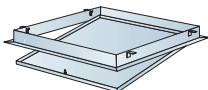

3. Connect Light fitting clip

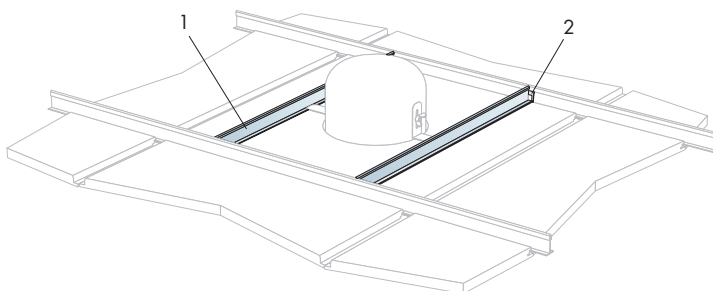
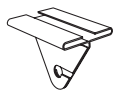

→ 24

1. Connect Bridging profile

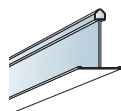

2. Connect Bridging clip 5/20



Ecophon[®]
SAINT-GOBAIN

A SOUND EFFECT ON PEOPLE

www.ecophon.com

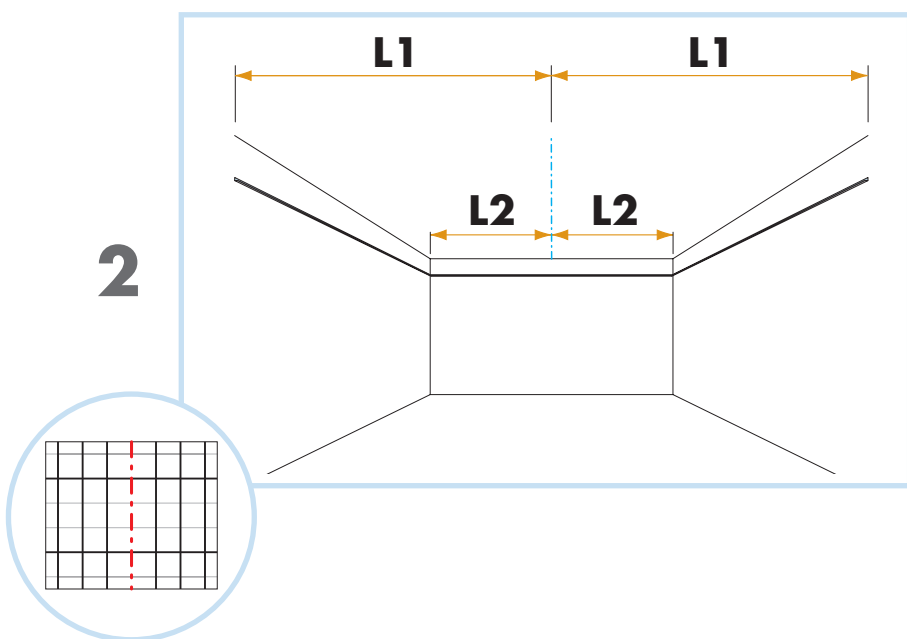
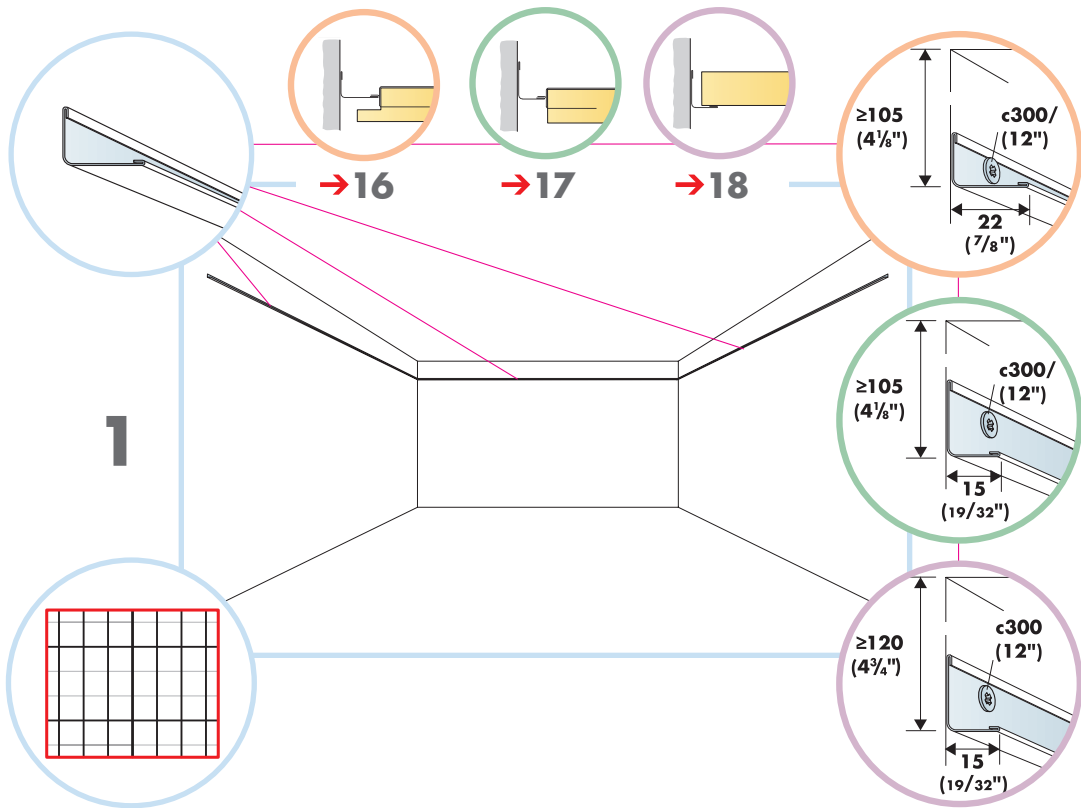

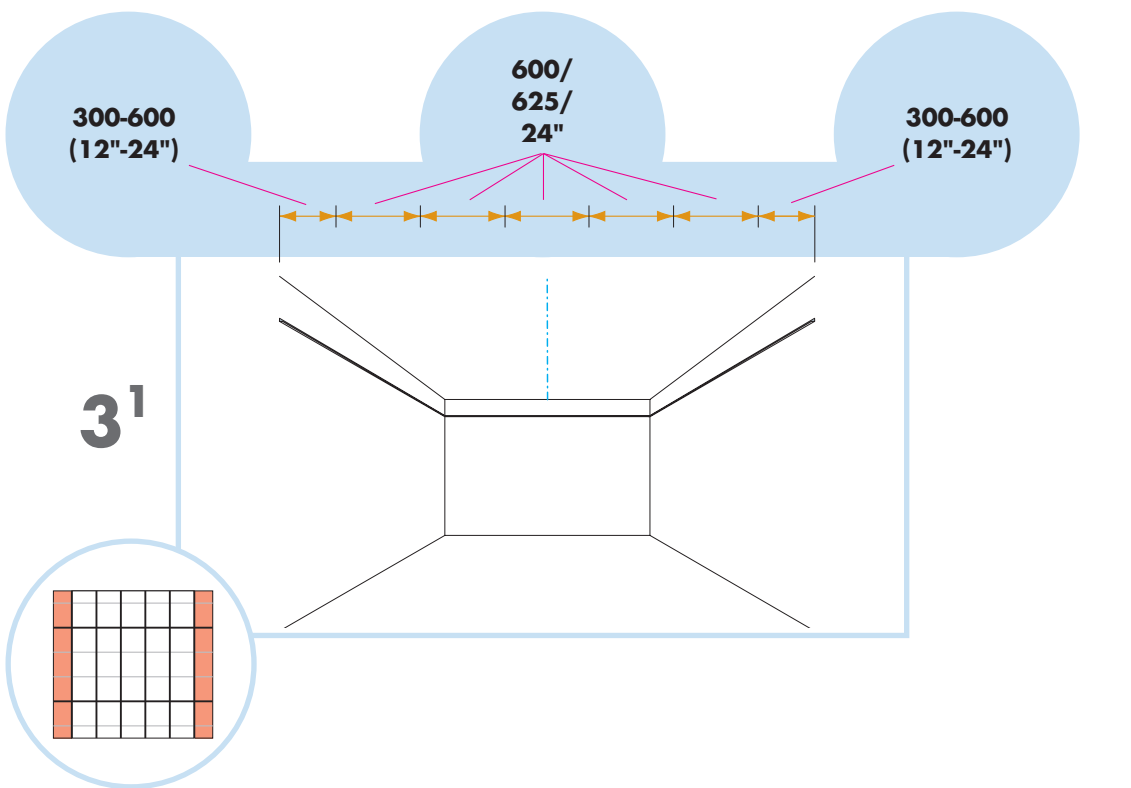
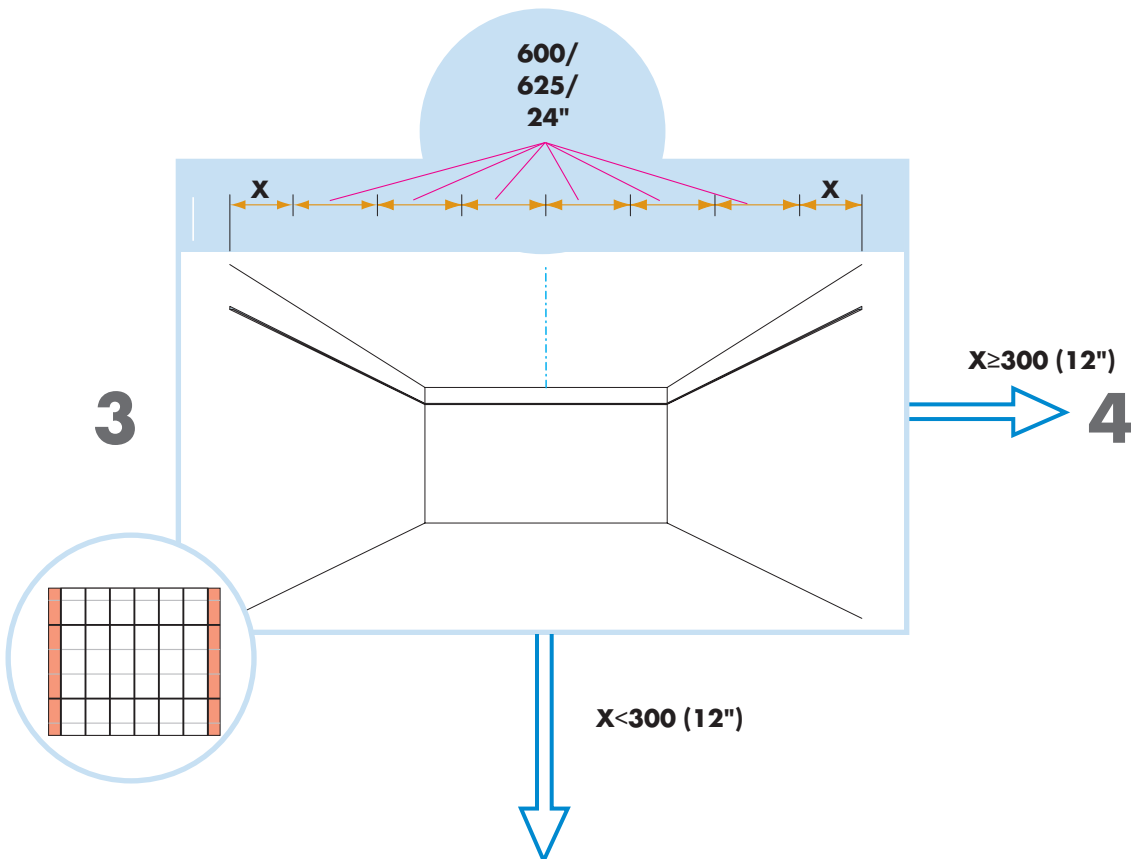

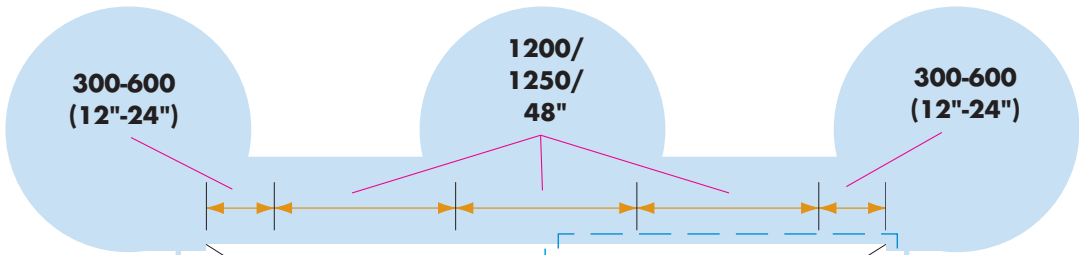

4

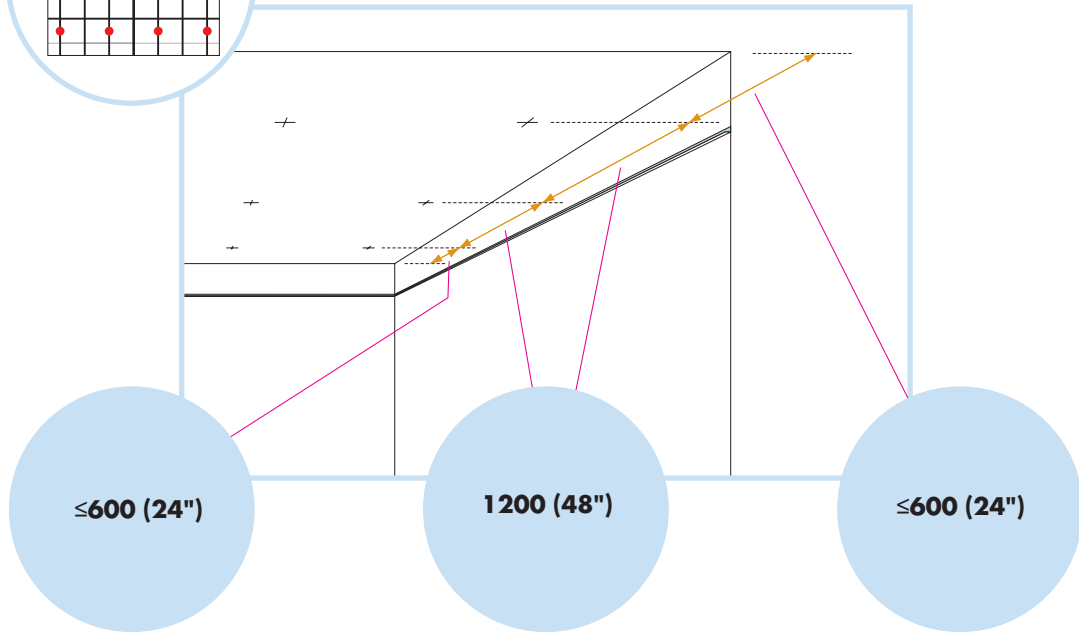
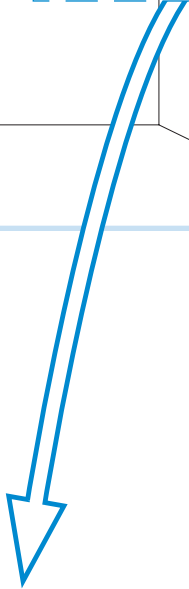
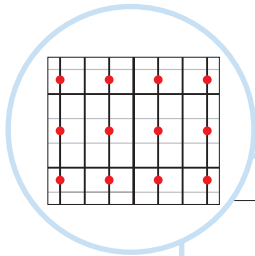
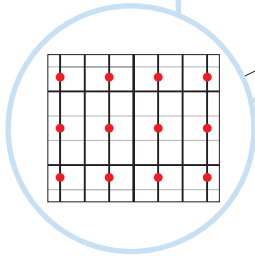

5

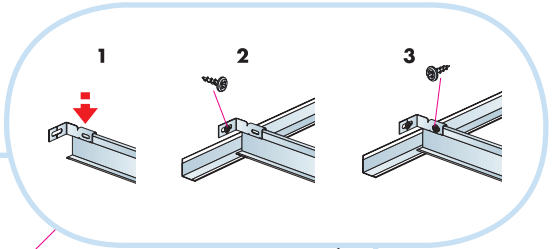
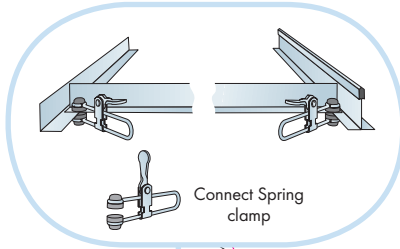
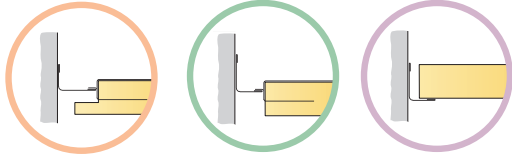
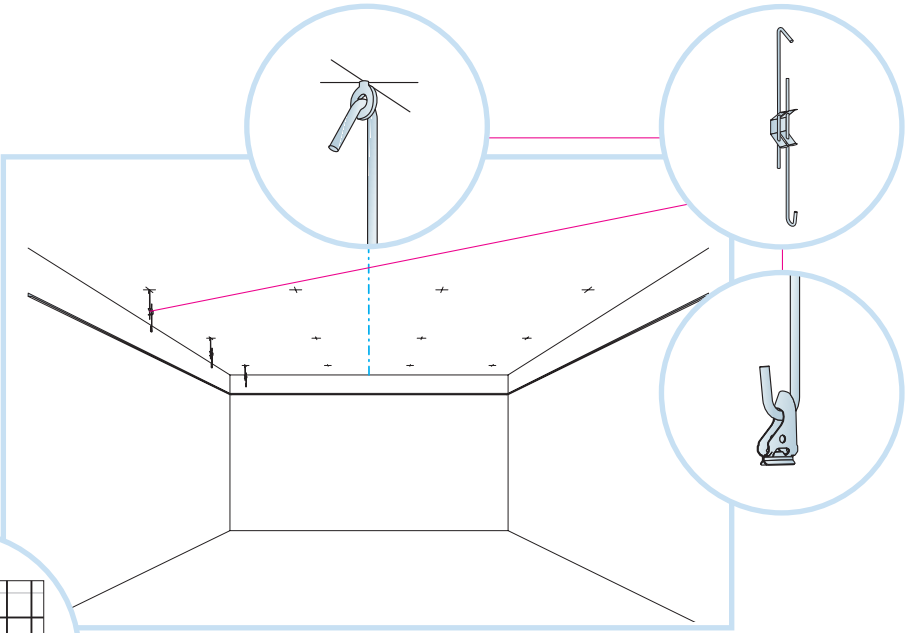
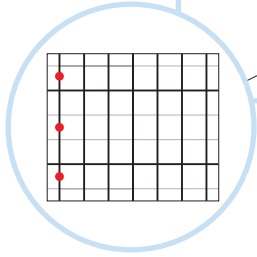

6

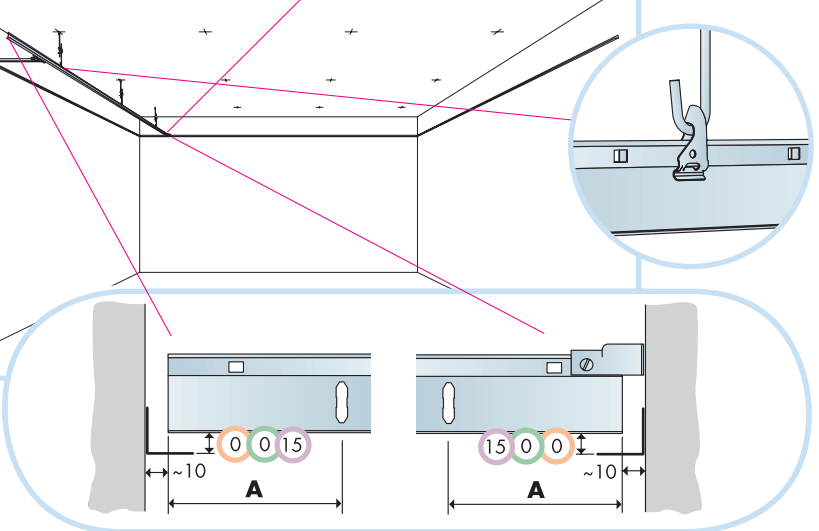
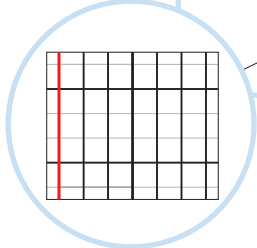

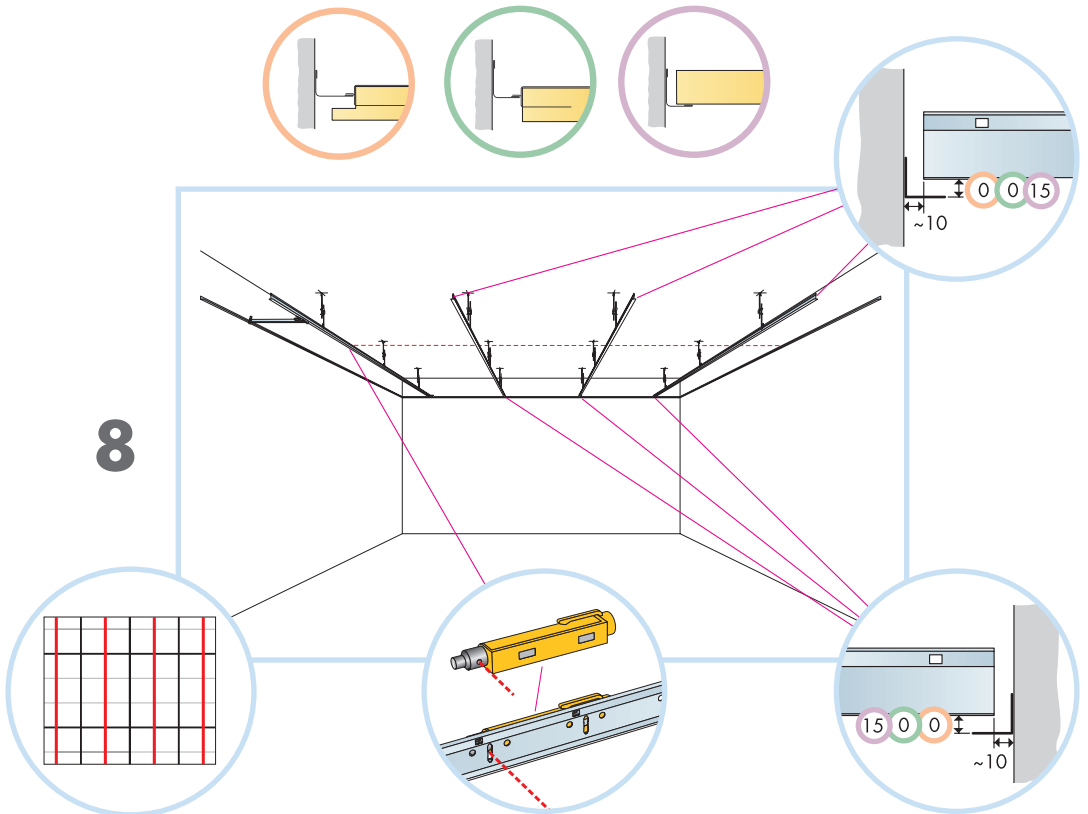
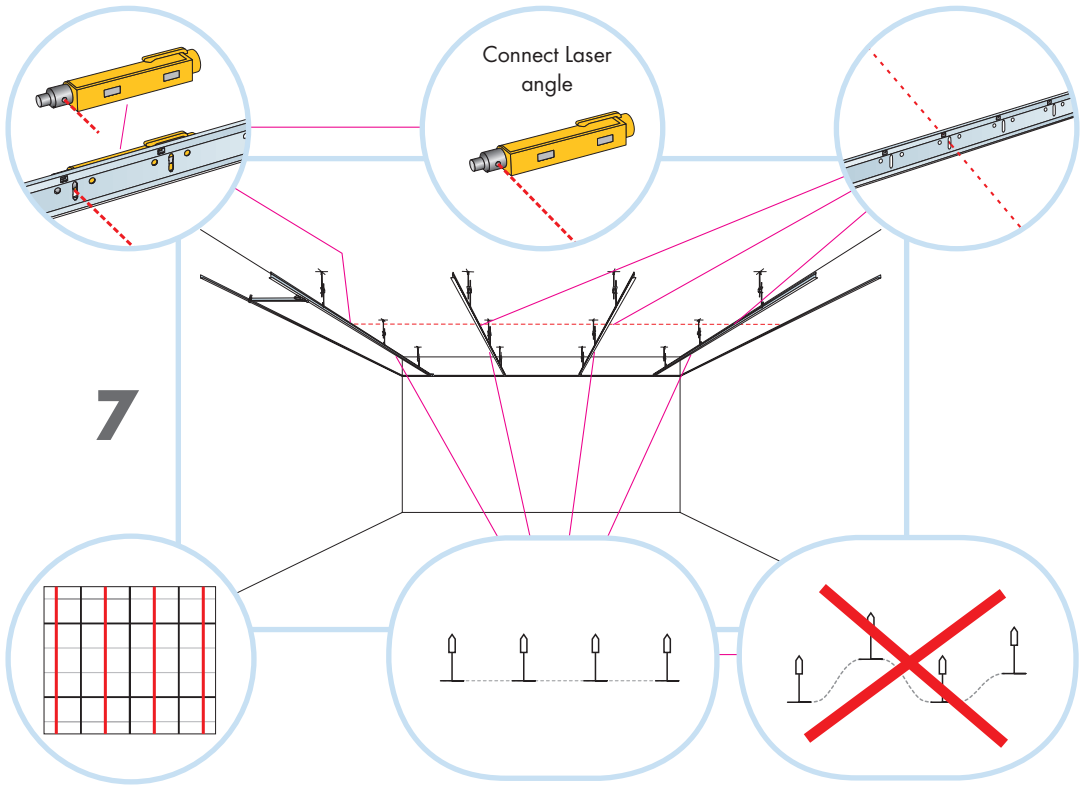

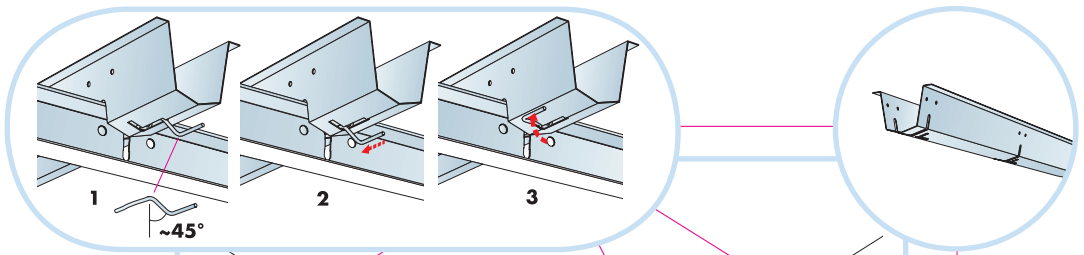

9

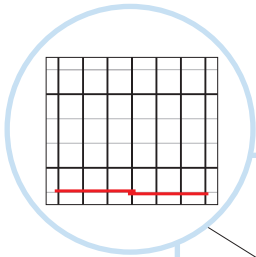
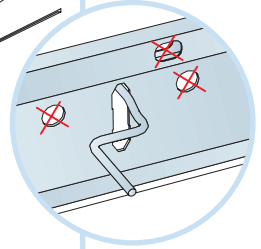
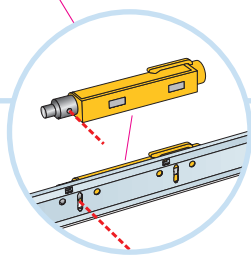
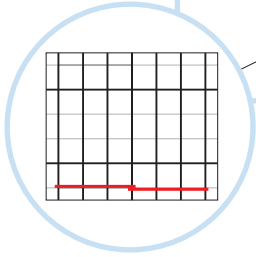

10

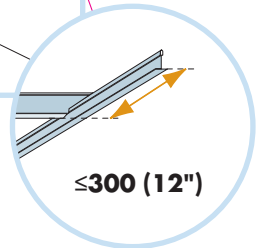
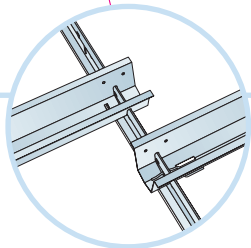
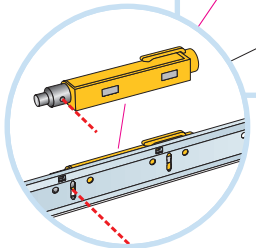

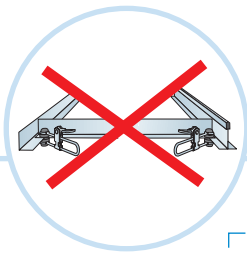
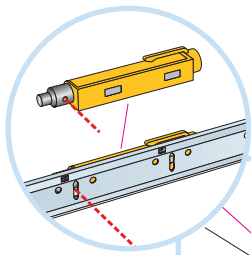

11

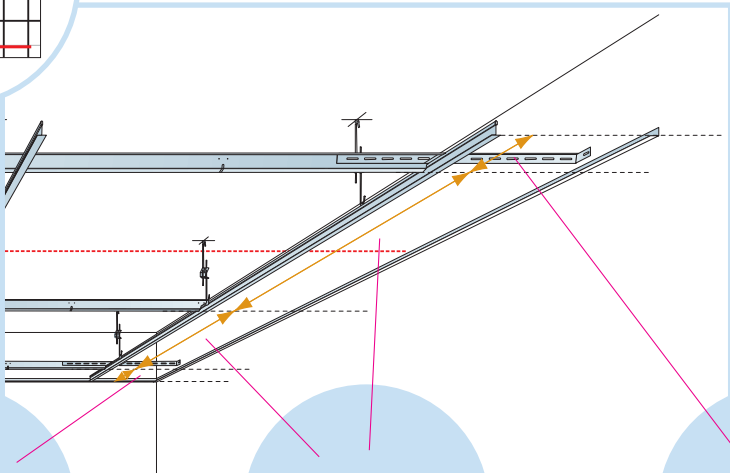
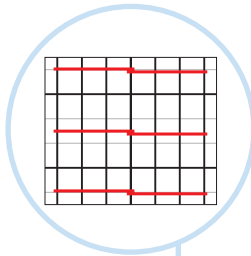
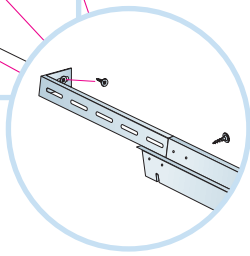
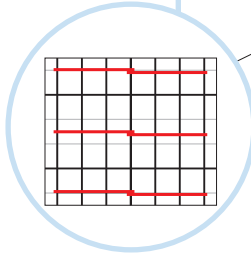
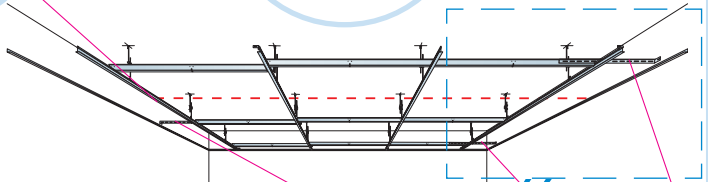

**≤300
(12")**

**1500
(60")**

**≤300
(12")**

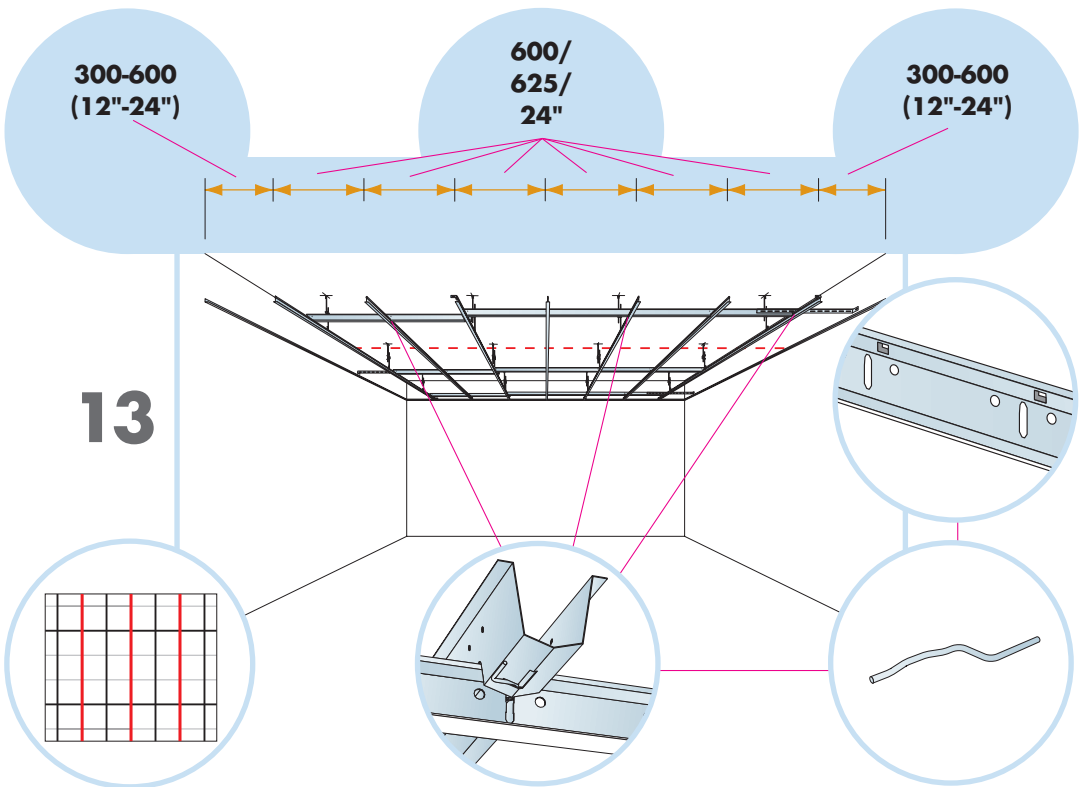
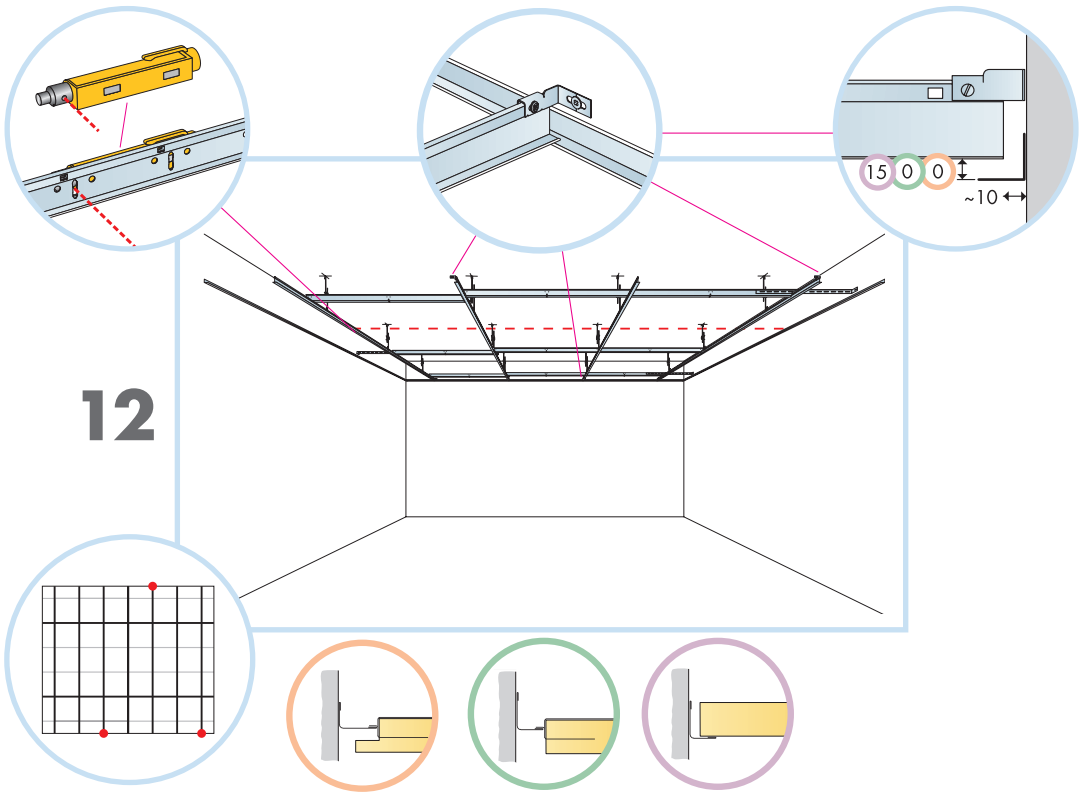

□ 600x600/
625x625/
24"x24" → 14

□ 1200x600/
1250x625/
48"x24" → 18

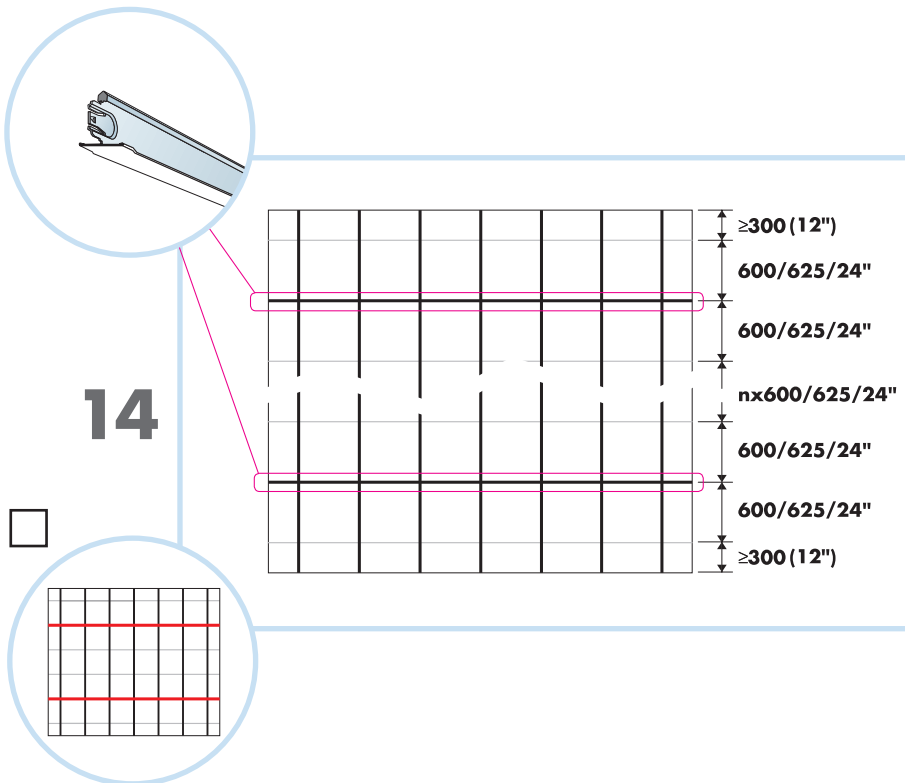

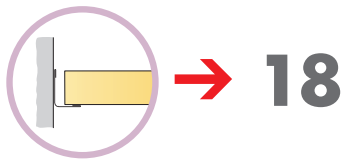
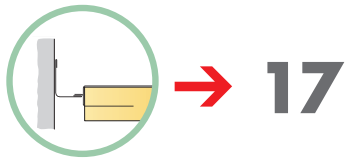
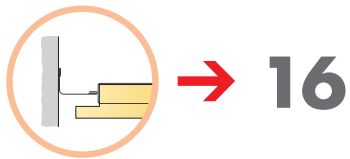
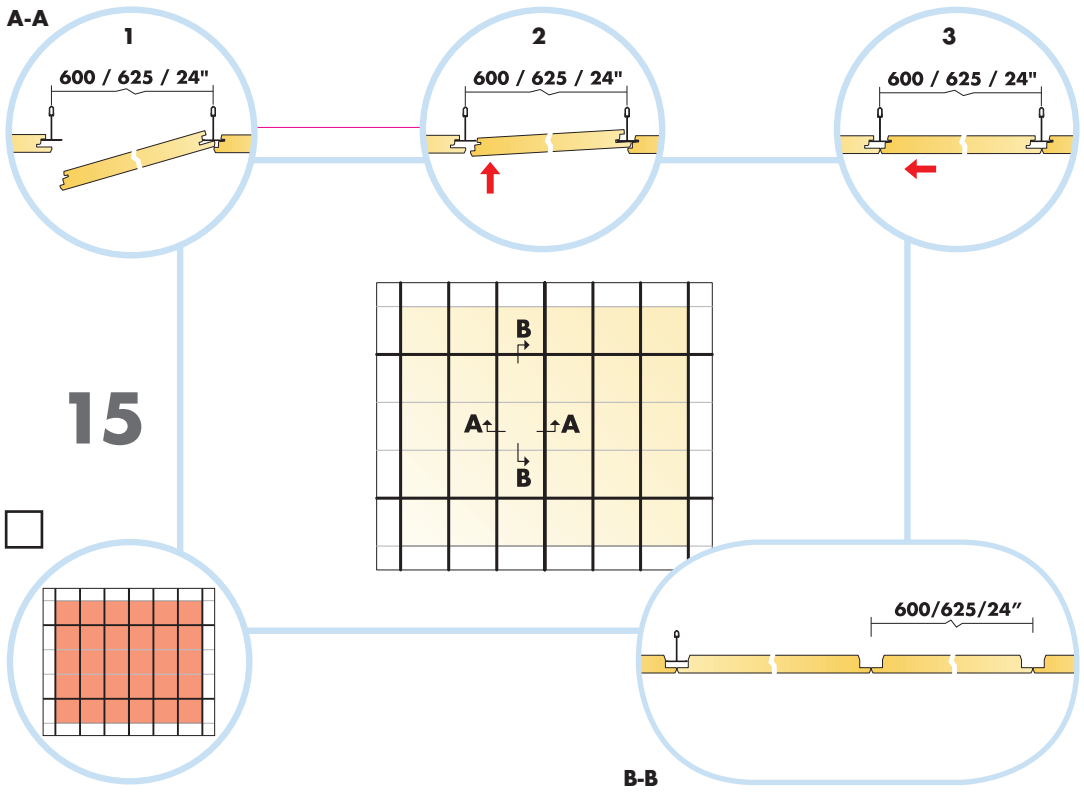

Cutting tool 0991

C-C

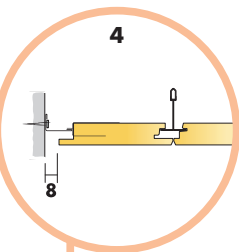
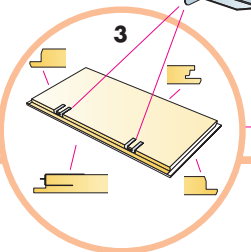
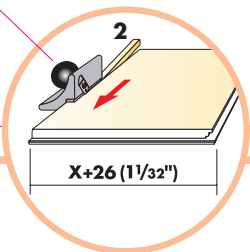
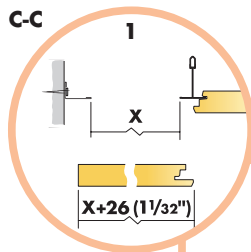

16

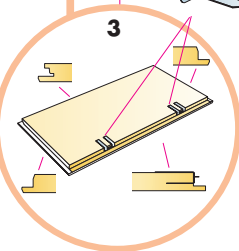
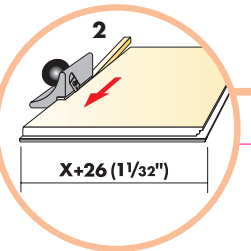
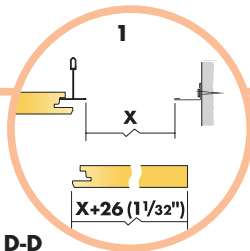
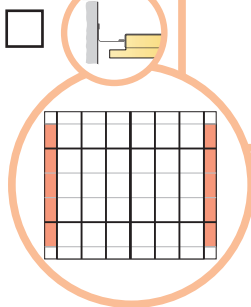
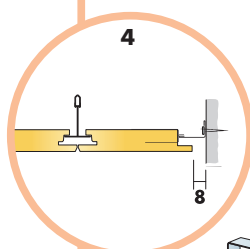
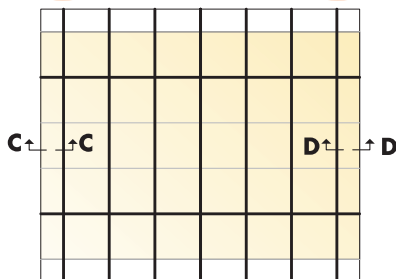

D-D

E-E

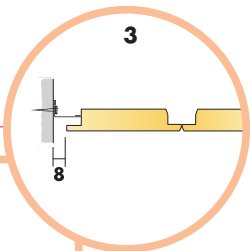
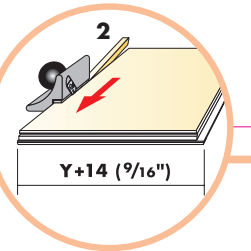
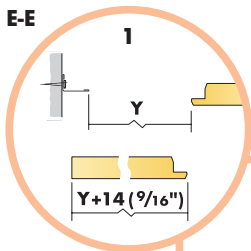

16'

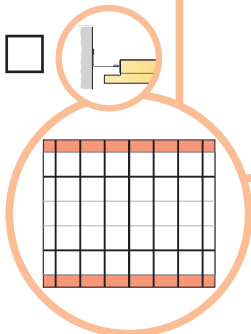
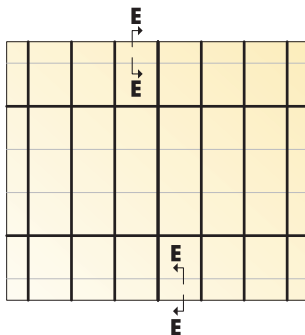

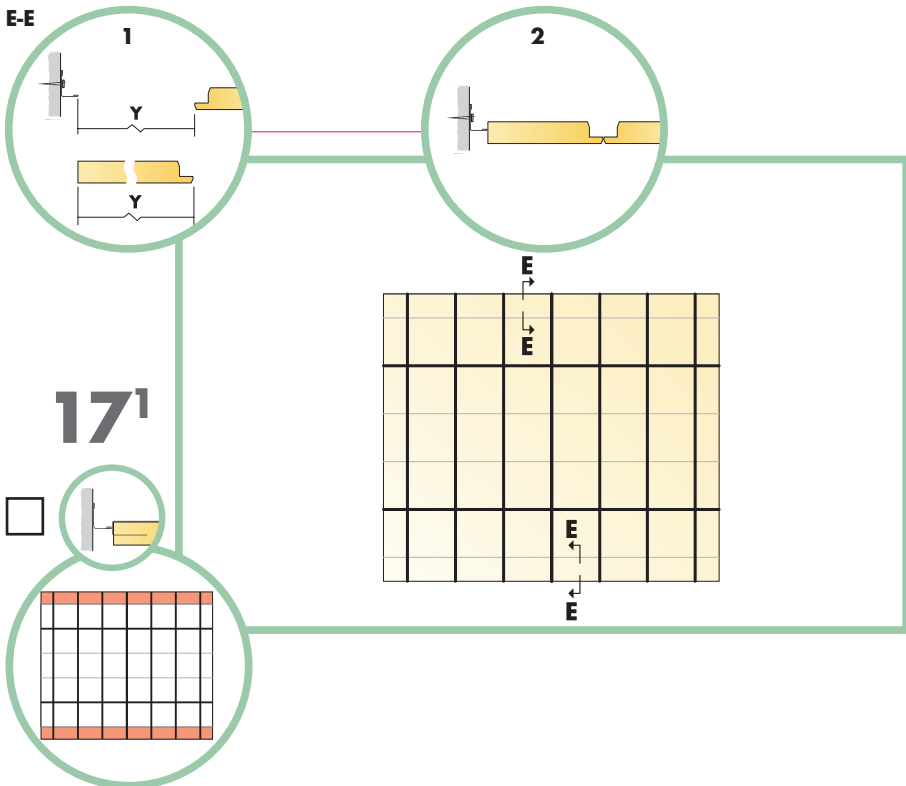
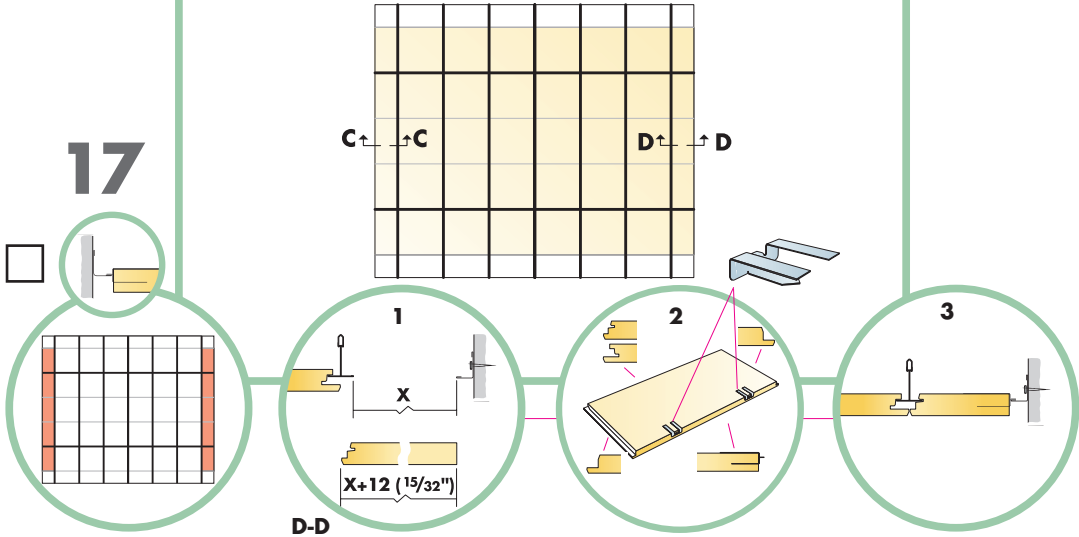
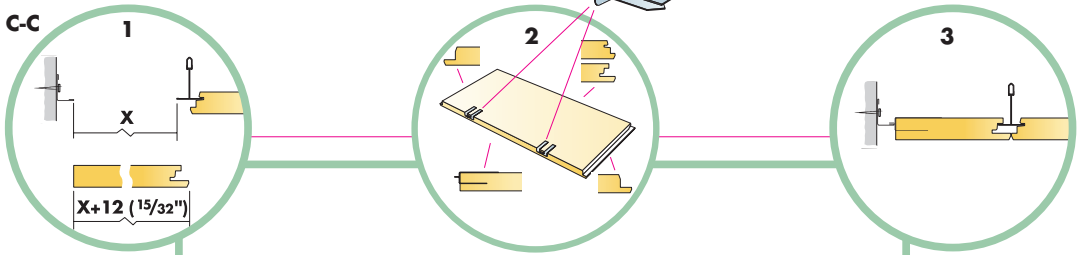

C-C

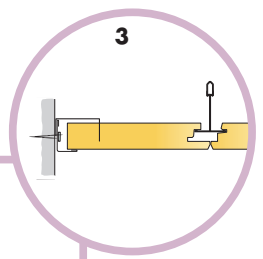
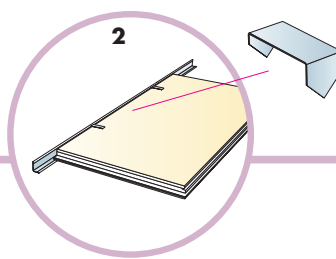
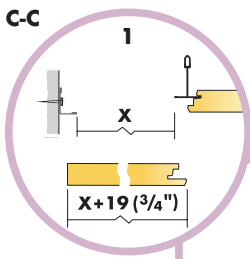

18

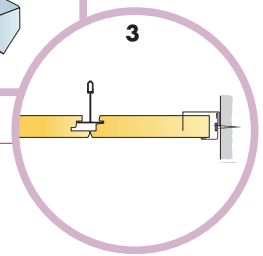
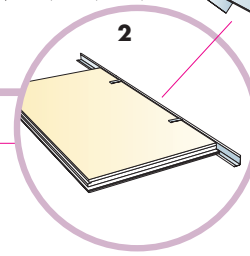
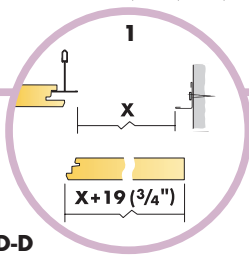
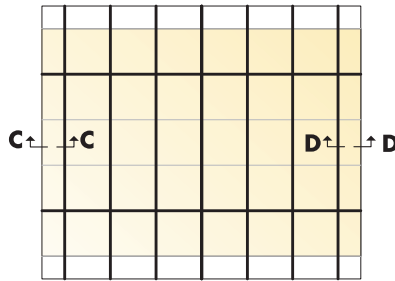
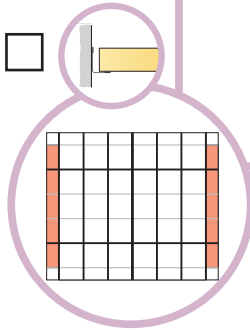

D-D

E-E

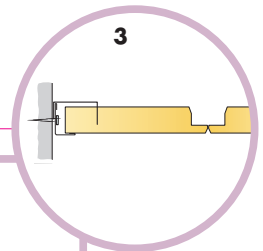
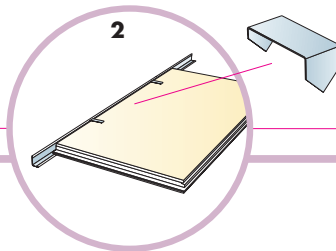
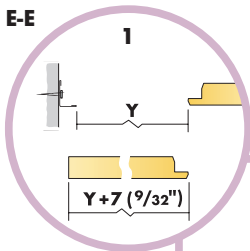

18¹

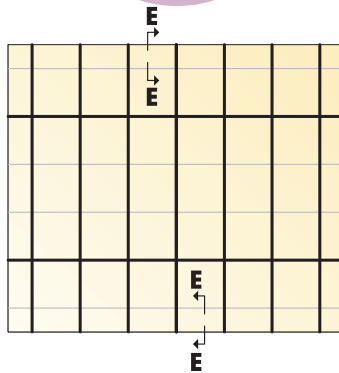
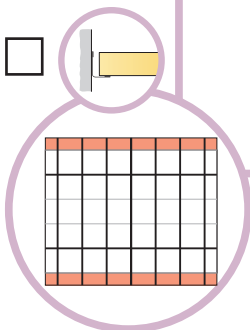

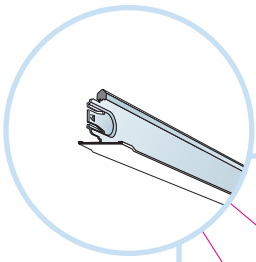

19

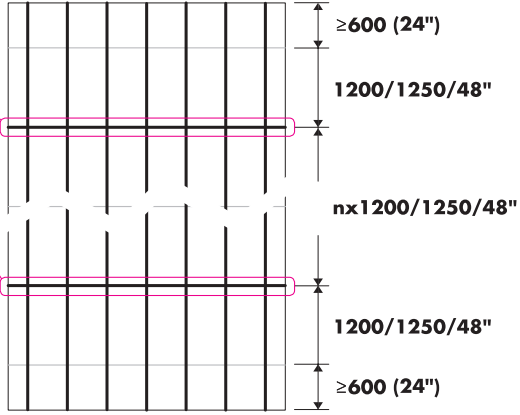
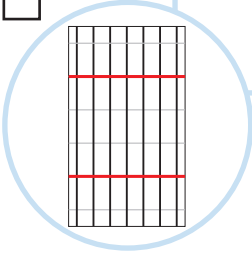

A-A

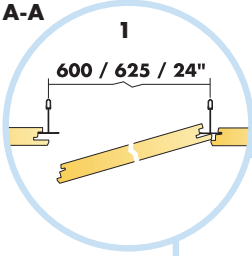

2

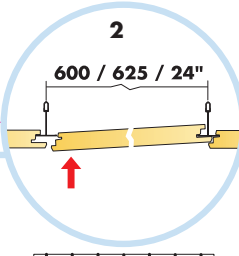

3

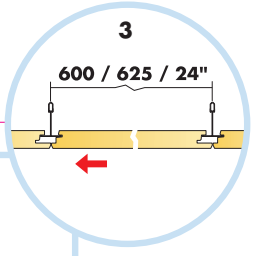

20

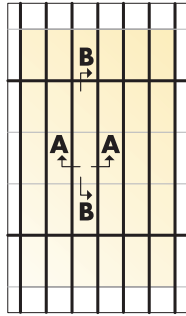
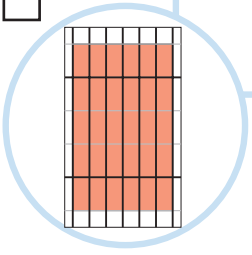

B-B

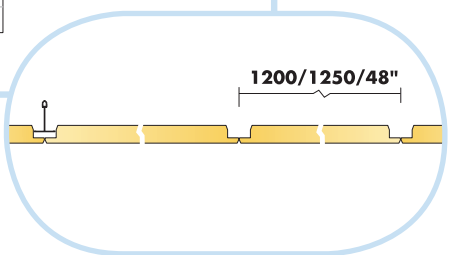

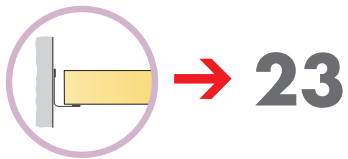
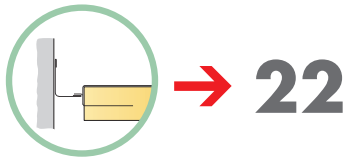
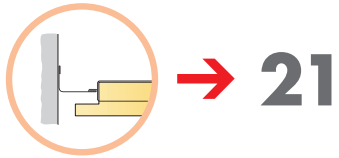

Cutting tool 0991

C-C

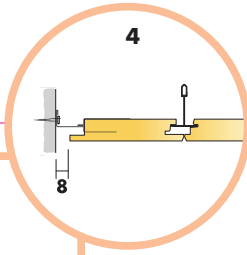
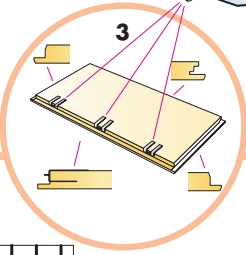
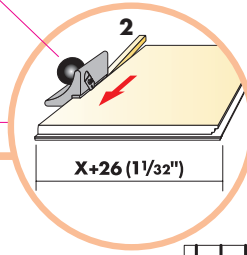
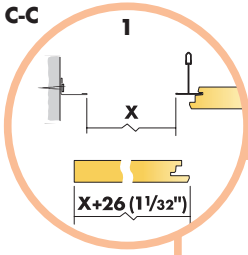

21

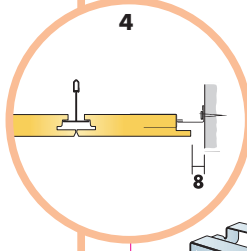
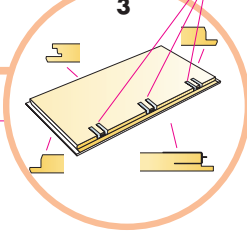
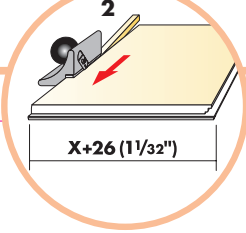
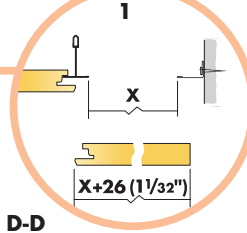
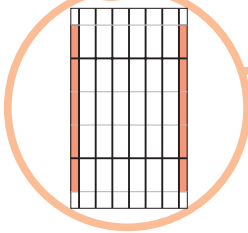

D-D

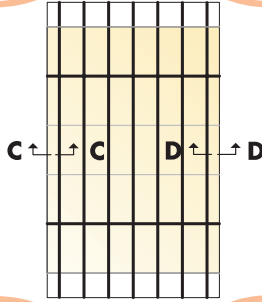

E-E

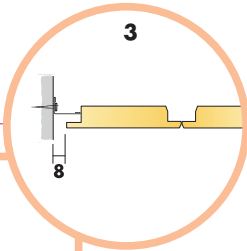
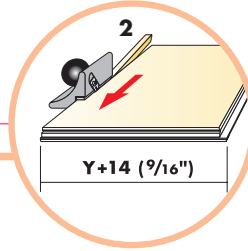
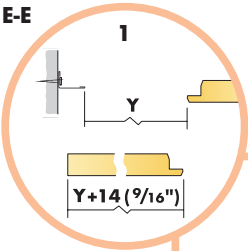

21'

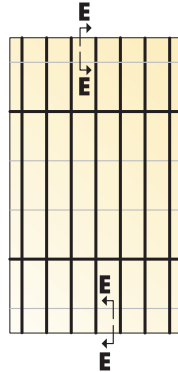
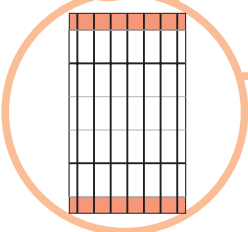

C-C

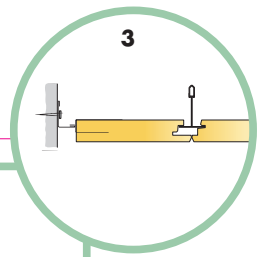
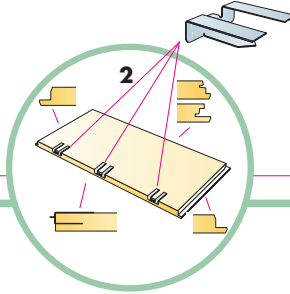
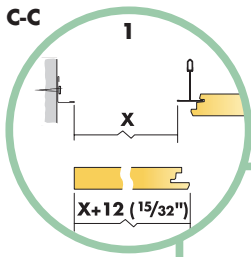

22

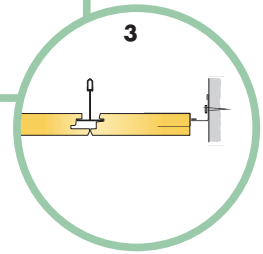
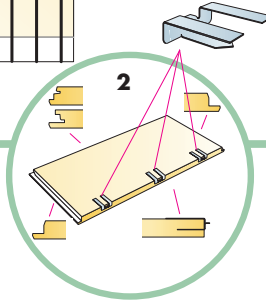
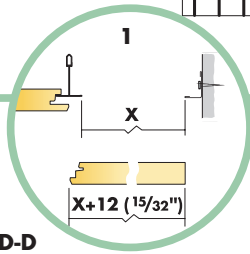
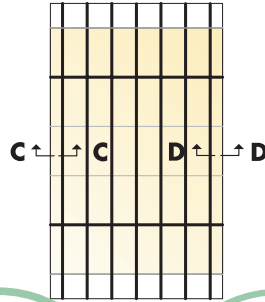
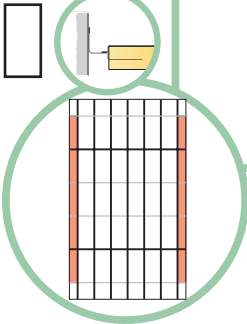

E-E

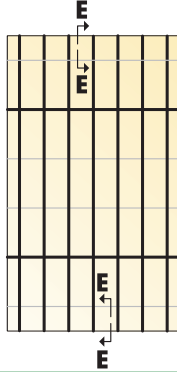
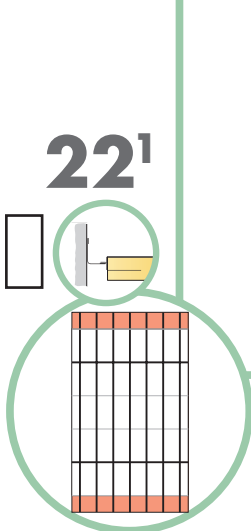
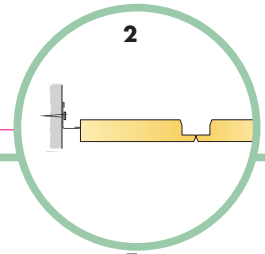
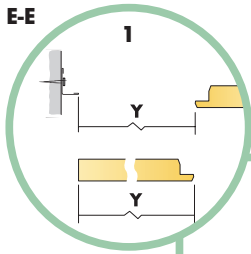

22'

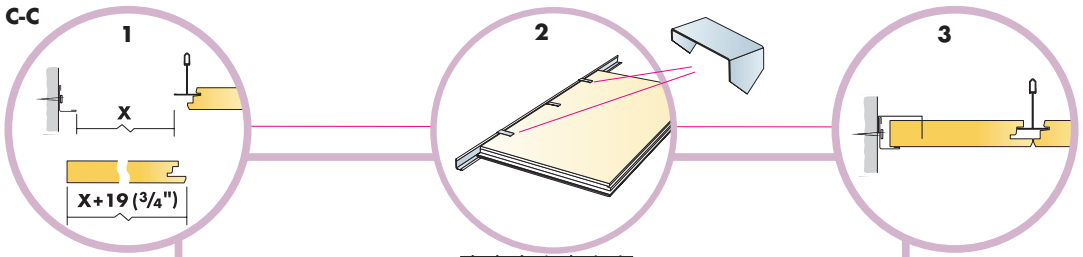

23

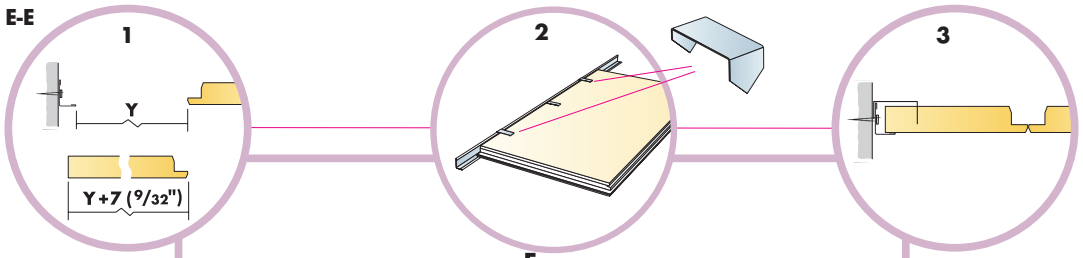
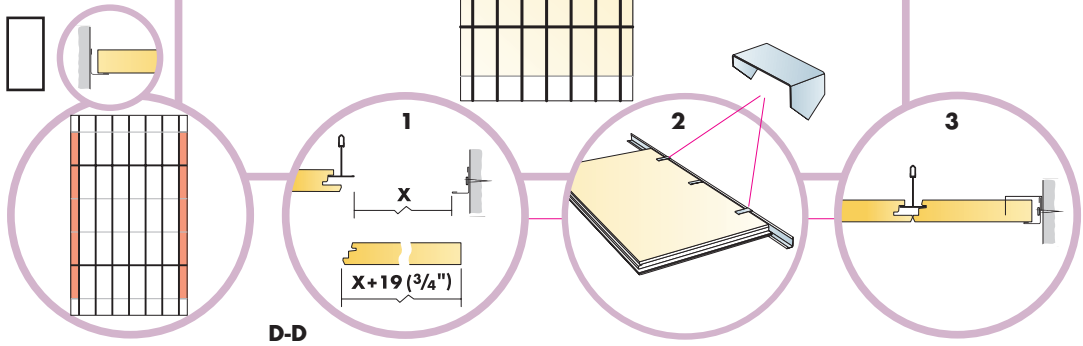

23¹

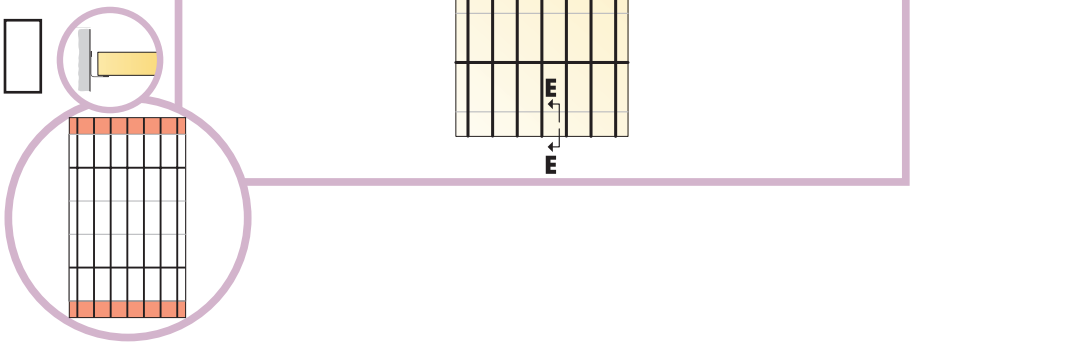

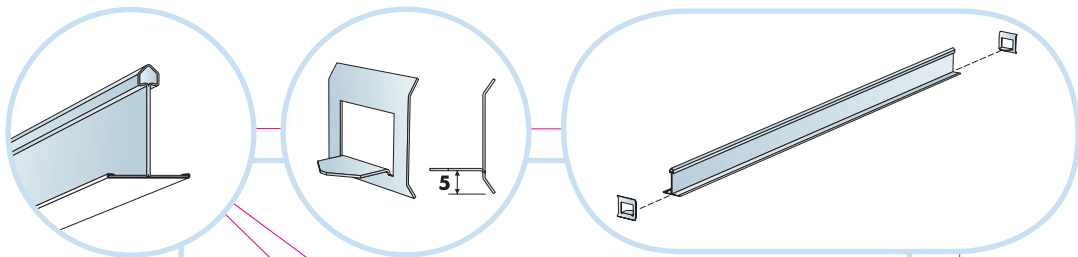

24

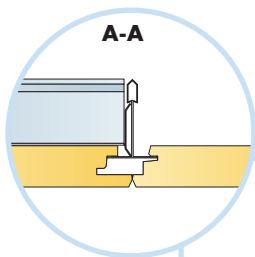
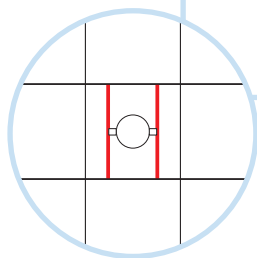
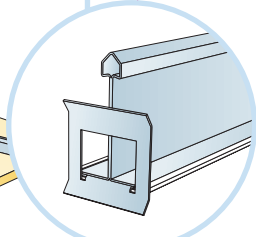
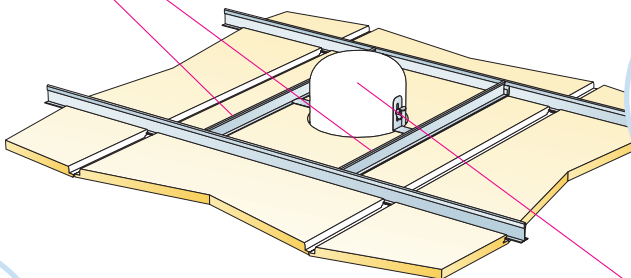

Alt 1

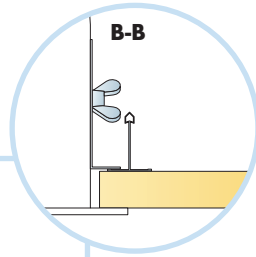

25

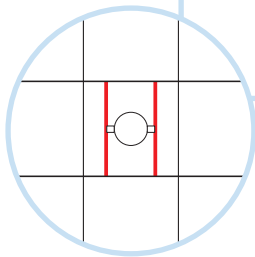
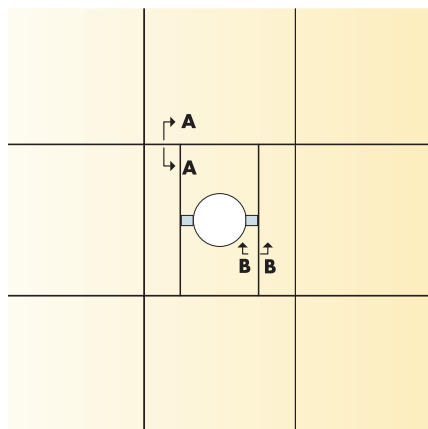

Alr 2

A-A

B-B

C-C

26

A
A

B
B

C
C

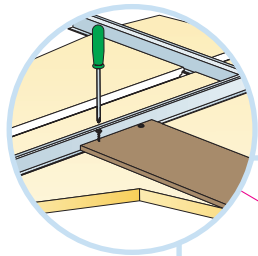
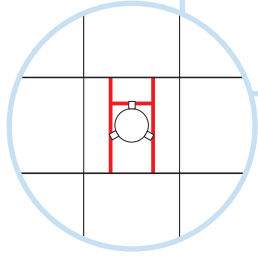

Alr 3

27

